

CLASSIC 55

Design Features :

Mechanical

- Proprietary die-casting heat sink for optimal thermal management.
- Interchangeable LEDIL® optics
- Quick connector
- Shallow recess depth for limited installation space

LED/Optics

- LM80 rated Philips Luxeon M LED Array.
- Less than 9.5 watt Power consumption
- Input Voltage: see the ordering code information
- Lumen output: > 530 (lm) delivered lumen
- CBCP : Spot 353cd/ Medium 284cd/ Wide 252cd
- Color Temp.: Warm White 2700K, 3000K, 3500K & 4000K optional
- CRI: > 80 (90 CRI optional)
- Optics : Spot 14 deg. / Medium 24 deg. / Wide 39 deg. options
- Life span: 50,000 hrs based on 70% lumen maintenance
- No harmful ultra violet light, infrared wavelengths
- Warranty: 5 years

Electrical

- Remote Class 2 driver, Power Factor > 0.90.
- TRIAC/ELV or 0-10V dimmable (optional)
- Overload & short circuit protection

Approval / Certificate

- Dry and Damp Locations.
- RoHs compliant.

Recommended LED Driver :

Driver No	Input Voltage	Dimming	Note
DE-1-700-10	120V	TRIAC/ELV	
DE-1-900-10	120V	TRIAC/ELV	Consult Factory
DE-4-700-10	220-240V	TRIAC/ELV	
DE-4-900-10	220-240V	TRIAC/ELV	Consult Factory
DX-2-700-10	120-240V	NON-DIMMABLE	1 Year Warranty
DA-3-700-10	120-277V	0-10V DIMMING	

Ordering Code Information:

PRODUCT	TRIM STYLE	LUMEN	COLOR TEMPERATURE	FINISH	BEAM ANGLE
CLS55	R	06	27	WHA	S
CLS55	S Square R Round	06 600lm	27 (2700K) 30 (3000K) 35 (3500K) 40 (4000K)	WH (White) BK (Black) AL (Aluminium) WHA (White/Aluminium) WHB (White/Black) ORB (Oil Rubbed Bronze)	S (Spot)/ 14deg. M (Medium)/ 24 deg. W (Wide)/ 39deg.



Dimension:

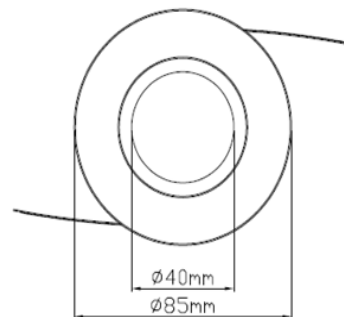
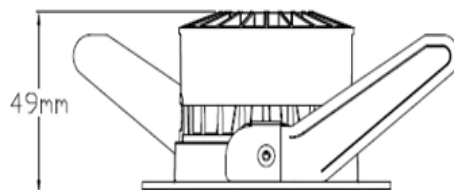

Macron Associate Co.
ISO9001:2008



41146 #352, Peng-Yi Road, Taiping, Taichung, Taiwan R.O.C.

TEL : +886-4-22708357 FAX : +886-4-22774516

www.macrongroup.com

Copyright © Macron. All technical information in this document is subject to change.

VER.2

CLASSIC 55

Photometric Data :

Distribution Curve

CLS55

14° Beam Spread

3000K

>530 lm

Efficacy > 56 LPW

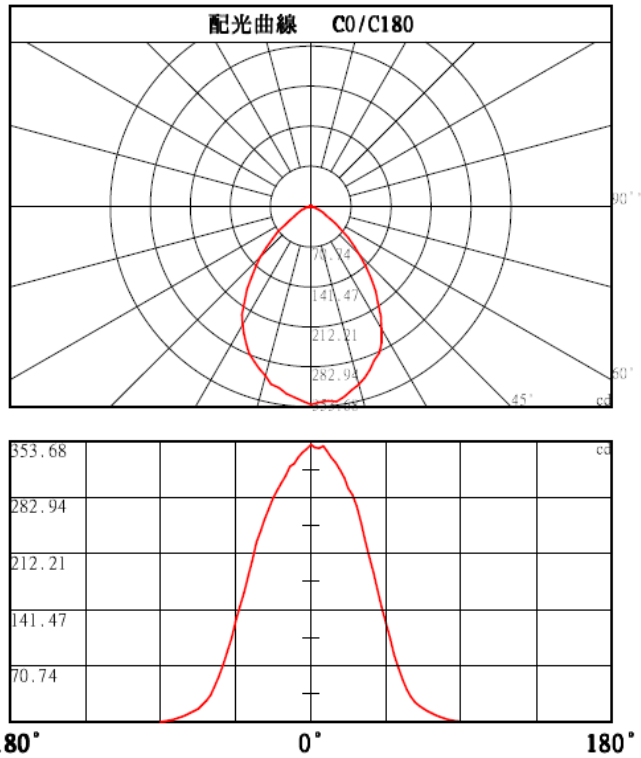

照度距離曲線

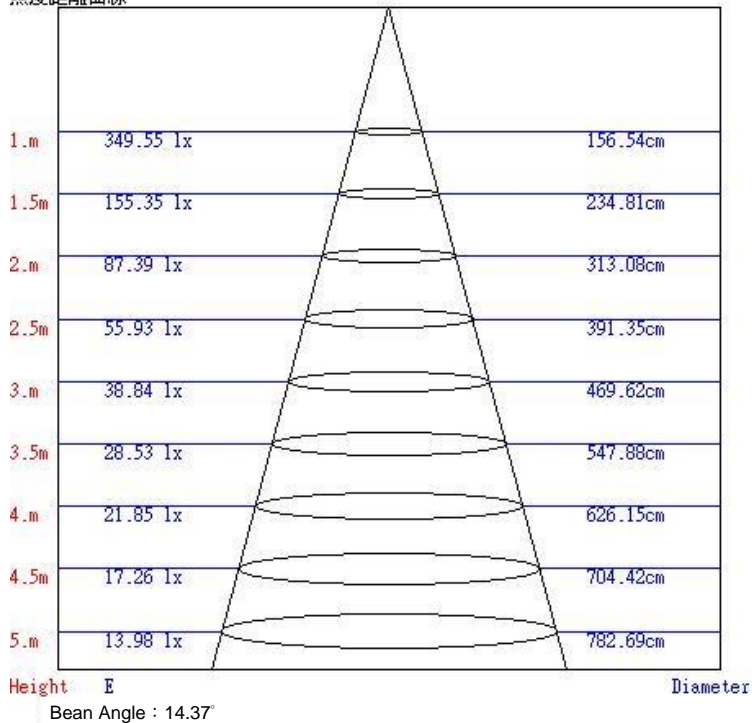

Macron Associate Co.
ISO9001:2008



41146 #352, Peng-Yi Road, Taiping, Taichung, Taiwan R.O.C.

TEL : +886-4-22708357 FAX : +886-4-22774516

www.macrongroup.com

Copyright © Macron. All technical information in this document is subject to change.

VER.2

CLASSIC 55

Photometric Data :

Distribution Curve

CLS55

24° Beam Spread

3000K

>530 lm

Efficacy > 55 LPW

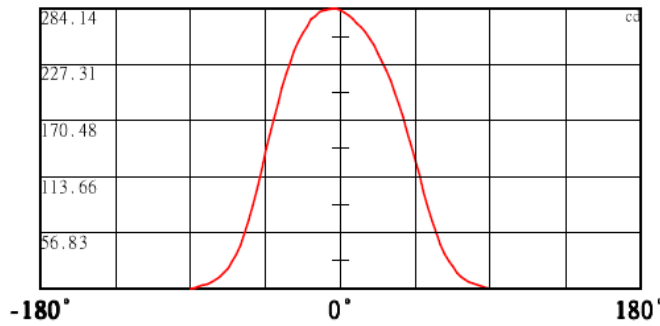
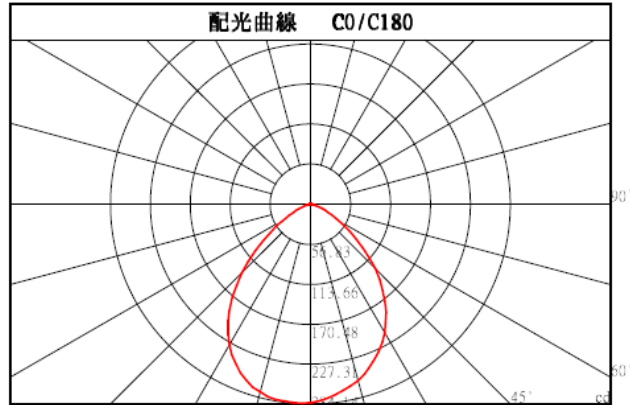

照度距離曲線

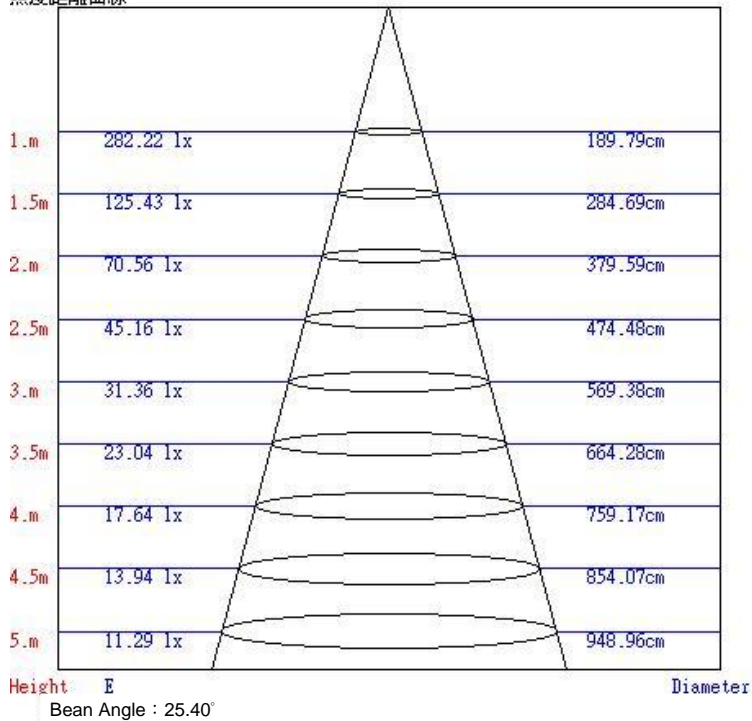

Macron Associate Co.
ISO9001:2008



41146 #352, Peng-Yi Road, Taiping, Taichung, Taiwan R.O.C.

TEL : +886-4-22708357 FAX : +886-4-22774516

www.macrongroup.com

Copyright © Macron. All technical information in this document is subject to change.

VER.2

CLASSIC 55

Photometric Data :

Distribution Curve

CLS55

39° Beam Spread

3000K

> 530 lm

Efficacy > 55 LPW

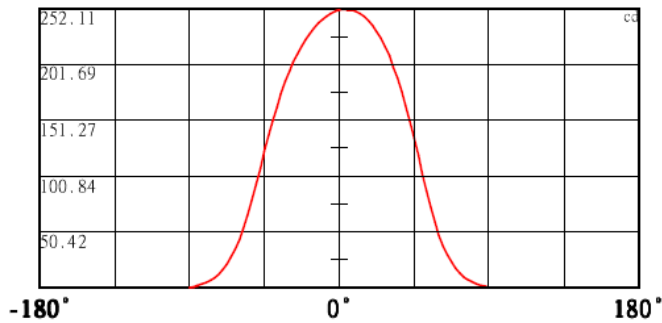
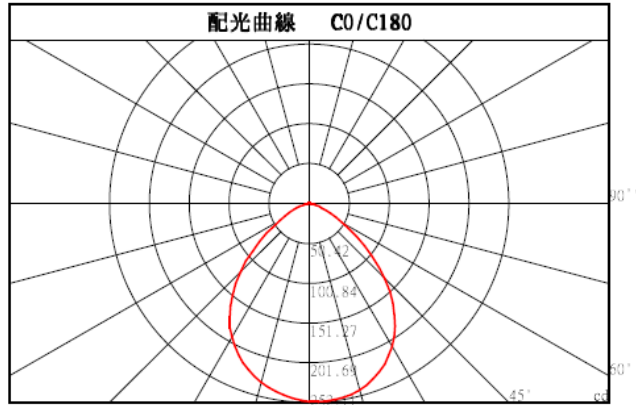

照度距離曲線

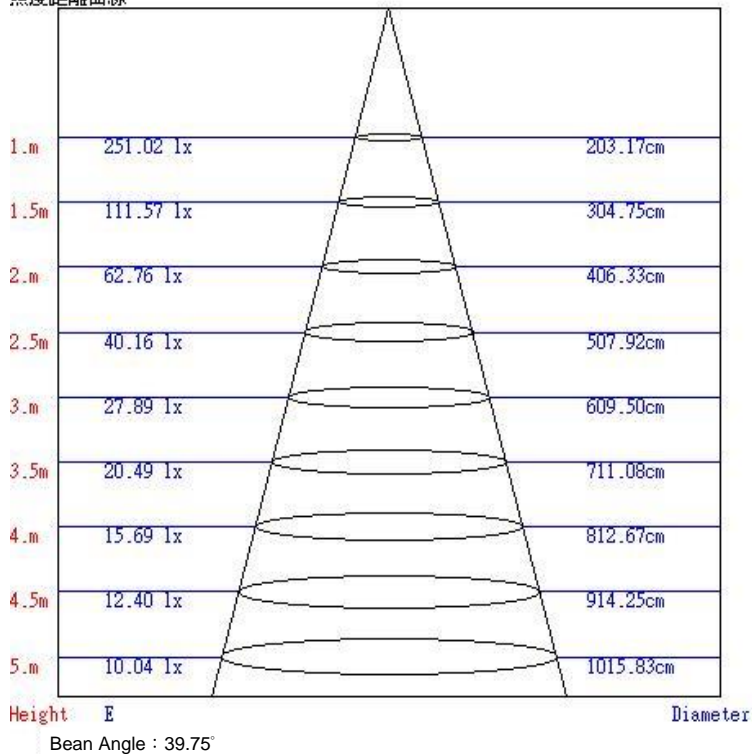

Macron Associate Co.
ISO9001:2008



41146 #352, Peng-Yi Road, Taiping, Taichung, Taiwan R.O.C.

TEL : +886-4-22708357 FAX : +886-4-22774516

www.macrongroup.com

Copyright © Macron. All technical information in this document is subject to change.

VER.2